

Athena QT-200 10X

10X PTZ Color Mini dome



Technical Specifications

HighLights

- High Quality Stepper Motors
- Zoom 100X
- Compatible with QT-69 Accessories
- Up to 160 Preset
- Multiprotocol
- Lighting Protection
- On Screen Menu Title
- DNR (Digital Noise Reduction)
- Day & Night (ICR)

High performance Pan & Tilt mechanism

The Quaddrix QT-200-10x mini speed dome is build in a strong and reliable Pan &Tilt structure, powered by a high quality stepper motors that provides speed and high precision Pan &Tilt movements and that is the reason for the dome's size and wieght.

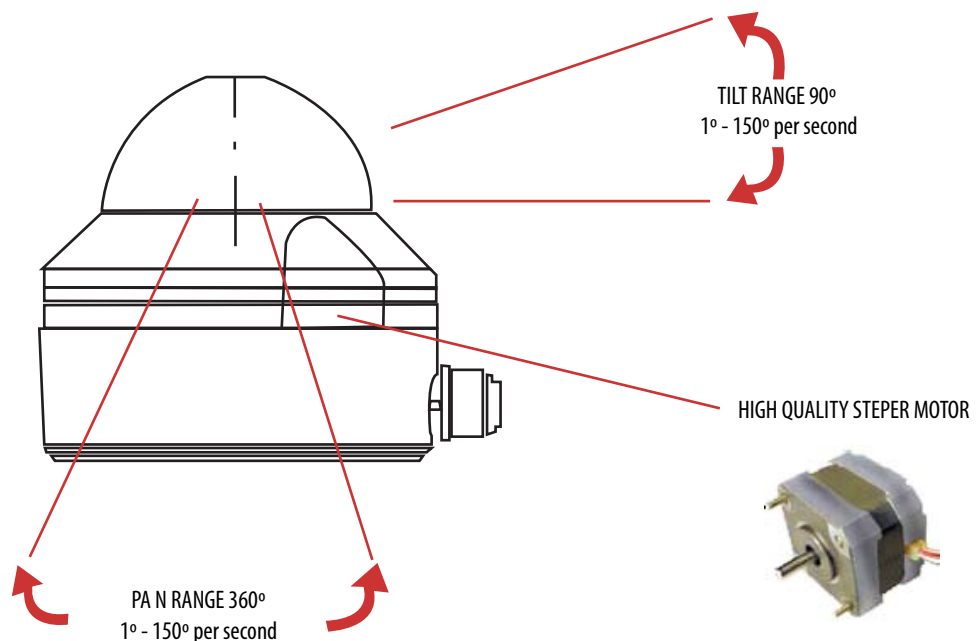

Quaddrix[®]
Mini Domes

Athena QT-200 10X

10X PTZ Color Mini dome



Technical Specifications

. DNR (Digital Noise Reduction)

The QT-200-10X counts with DNR technology that reduces Significantly the noise produced by low luminance and by the signal-to.noise ratio.

. 10x Optical Zoom

Built-in 10X optical zoom lens is highly reliable. It features Auto focus, Auto iris and Zoom tracking function.

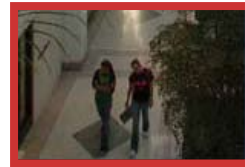

.High Resolution

the New QT-200-10X is equipped with a high resolution CCD video capture device, providing up to 500TVL in color mode and 570TVL in black and white mode, providing clean noiseless and more reliable images .

. Day & Night (ICR)

Infra Red Cut Filter that increase the mini dome's sensitivity in low light enviroments.

BRACKET

*Compatible with the QT-69Accessories, for Outdoor applications

SUNSHIELD

*Compatible QT-69 Accessories for Outdoor applications

IN CEILING MOUNT ACESORIES

*Included with the MiniDome



*Accesories and Power Supplies are not included, sold separately

Quaddrix[®]
Mini Domes

Athena QT-200 10X

10X PTZ Color Mini dome



Technical Specifications

Technical data table of the MiniDome

Pan range	360°
Tilt range	0-90°
Preset location	160 presets
Tours	8 Tours, 7 speeds
Scan mode	1 scan, 7 speeds
360° run mode	7 speeds
OSD system	Setup Parameter, Setup Title, XY position, Auto Clear Screen
Protocol	PELCO-D, PELCO-P, HTS, ALEC, LILIN, VIDO-B01, SAMSUNG
Baud rate	9600bps, 4800bps, 2400bps, 1200bps
Pan Tilt speed	Min: 1°/s, Max: 150°/s
Communications mode	RS485 bus, max distance: 1200m
Power supply	12VDC 1.5 Amp

Technical data table of the CAMERA

Image Sensor	1/4" inter liner transfer CCD
Auto iris	Yes
Auto focus	Yes
Zoom	100X (optical 10X, digital 10X)
Resolution (TVL)	500TVL at Color mode and 570TVL at BW mode
sensitivity	0.7Lux (color); 0.02Lux (B/W)
Effective pixels	768(H)*494(V)
Focal length	3.8~38.0mm
Angle of view	H: 51.2°(wide) – 5.58°(tele); V:39.3°(wide) – 4.27°(tele)
Sync system	Internal / VD-lock
S/N	50dB (AGC off)
Scan system	2:1 interlacing
White balance	Auto / manual
BLC	Low / middle / high / off (selectable)
Video output	BNC 1.0Vp-p

Quaddrix[®]
Mini Domes

Athena QT-200 10X

10X PTZ Color Mini dome



Technical Specifications

Wall Mount Accesories

QT-200-WB

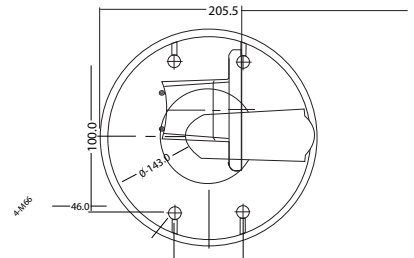
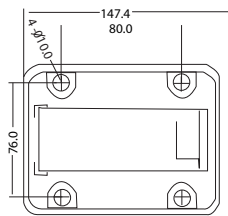

Pendant Mount Accesories

QT-200-PEB

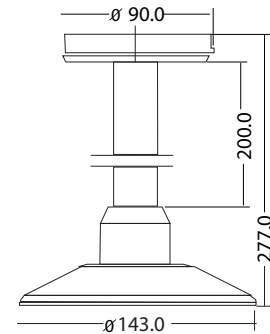
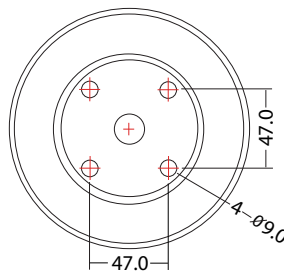

Housing Protection for outdoor Applications

QT-200-SHD

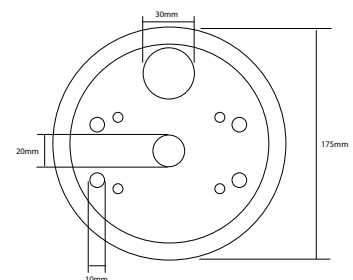
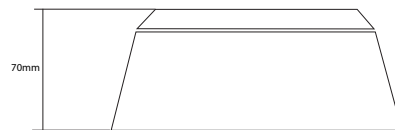

Quaddrix[®]
Mini Domes

Accesories Compatible with QT-200-10X, QT-680C/VR/VP and QT-690C/VR/VP/HR